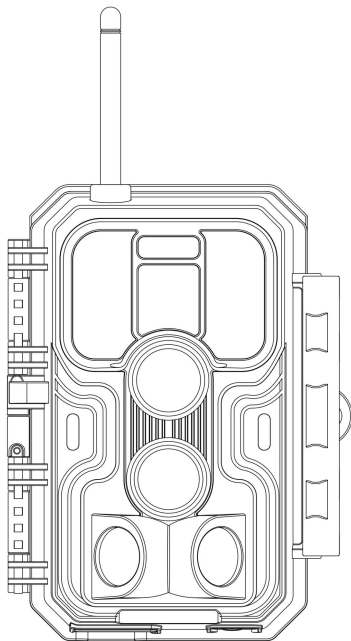


# Meidase

## P200 TRAIL CAMERA



## INSTRUCTION MANUAL

Doc V1.0

Congratulations on your purchase of one of the best trail cameras on the market! We appreciate your business and want to earn your trust. Please refer to the notes below and the instructions in this manual to ensure that you are completely satisfied with this product.

In case of any further questions or concerns, please get in touch with us at:

**support@meidase.com**

or visit our page for FAQs or latest firmware:

**www.meidase.com**

## TABLE OF CONTENT (English)

1. IN THE BOX .....	1
2. IMPORTANT NOTE .....	1
3. INTRODUCTION .....	2
4. PARTS AND CONTROLS .....	3
5. INSTALLING THE BATTERIES AND SD CARD .....	7
6. USING THE CAMERA .....	8
7. THE OFF, ON, AND SURVEILLANCE MODES .....	9
7.1. <i>OFF Mode</i> .....	9
7.2. <i>ON Mode</i> .....	10
7.3. <i>SURVEILLANCE Mode</i> .....	10
8. Wi-Fi CONNECTION .....	11
8.1. <i>Download Meidase Mobile App</i> .....	11
8.2. <i>Enable Wi-Fi and Bluetooth</i> .....	12
8.3. <i>Add Your Camera</i> .....	12
8.4. <i>Search Your Camera and Link</i> .....	13
8.5. <i>App Navigation</i> .....	15
8.6. <i>Important Notes on App Wi-Fi Connection</i> .....	17
9. ADVANCED SETTINGS .....	18
10. MOUNTING AND POSITIONING .....	23
10.1. <i>Mounting</i> .....	23
10.2. <i>Sensing Angle and Distance Test</i> .....	24
10.3. <i>Starting</i> .....	25
11. REVIEW PHOTOS OR VIDEOS .....	26
12. TECHNICAL SPECIFICATIONS .....	27
13. TROUBLESHOOTING .....	29
14. WARRANTY .....	30

## **1. IN THE BOX**

1 x Camera, 1 x Mounting Strap,  
1 x Instruction Manual, 1 x Mini USB Cord, 1 x Antenna

*Note: Memory card and batteries are not included (user supplied).*

## **2. IMPORTANT NOTE**

### ***2.1. About Batteries***

Require eight (8) 1.5V AA Alkaline or Lithium batteries. We recommend the use of Energizer AA Lithium batteries in this camera to obtain maximum battery life.

Do not mix old and new batteries. Do not mix battery type.

Rechargeable NiMH AA batteries can be used, but the lower voltage (generally 1.2V) they produce has short lifetime, you may have to replace them frequently.

Remove batteries when the camera is NOT in use.

### ***2.2. About SD Card***

Require a standard-size SDHC/SDXC memory card (maximum capacity 512GB, Class 10). Recommend using SanDisk 32GB SDHC Class10 memory cards in the camera to obtain the best cost-performance.

**Before first use, please format your SD card in the camera by using "Format SD Card" in the menu settings.**

### ***2.3. About App Wi-Fi Connection***

**Please refer to *Section 8* for details.**

For better performance, we recommend that your phone is within 15 meters (45 feet) of your camera. Since there may be

interference around, if the signal is not good, please move closer to the camera gradually.

*Legal attribution:* Apple and the Apple Logo are trademarks of Apple Inc., registered in the U.S. and other countries. Google Play and the Google Play logo are trademarks of Google LLC.

### **3. INTRODUCTION**

#### ***3.1. About the Camera***

The Meidase P200 is a new generation of Wi-Fi trail camera. The camera has a built-in Wi-Fi and Bluetooth module, so that you can connect and operate the camera through a dedicated App (“Meidase Mobile”). The Bluetooth module, operating in low power, is used for device discovery, and Wi-Fi is used for preview, image transmission and settings.

The camera features the all new innovative and ultra-clear Sony Starvis imaging technology. The camera encompasses all-new software innovations, smart illumination technology, blur reduction technology, auto noise reduction and dynamic exposure technology to deliver high resolution image quality.

#### ***3.2. Main Features***

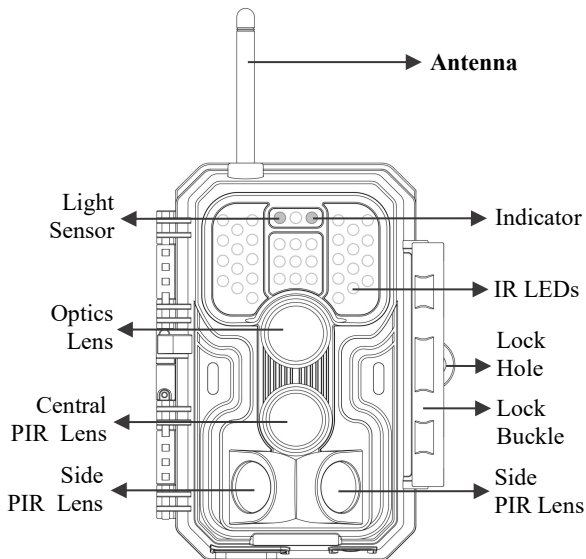
- Bluetooth connection for device discovery
- Wi-Fi connection for preview, playback, and settings
- High quality pictures (up to 48MP still photos), 1296P 20fps or 1080P 30fps H.264 video clips with audio
- Clear night vision, flash range 100ft. The camera is equipped with 36pcs high performance infrared no glow 940nm LEDs that function as a flash (invisible to human and animal eyes)
- Wide view angle - 70°

- Easy to use/program with well-designed operation buttons and built-in 2.4-inch color screen, easy to program, review pictures and videos on the screen
- Two working modes - Motion detection and Time lapse
- Fast trigger time approx. 0.1~0.5 seconds (pre-activated technology with 3 PIR sensors designed), Fast recovery time of less than 0.5 seconds, Long trigger distance up to 90ft
- Info strip on each capture: Date, Time, Temperature & Moon phase
- Operation Hours, Loop Recording, Time Lapse, Password Protected
- Built for any climate - IP66, Operation Temperature: -4 ~ 140°F / -20 ~ 60°C
- Support SD/SDHC/SDXC memory card, max capacity 512GB (*not included in the scope of delivery*)
- Extremely long in-field battery life up to 8 months in a stand-by state with 8 AA 1.5V batteries (*not included in the scope of delivery*)

#### 4. PARTS AND CONTROLS

The camera is equipped with 36pcs high efficiency infrared LEDs, LED Indicators, Lens, PIR Sensors, Lock Holes in front view (*Figure 1*).

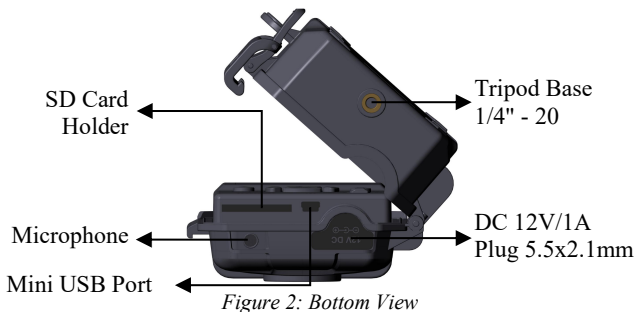
**TIP:** During use, the black PIR Lens may be dirty or have scratches, however it does not affect the performance due to the reliability design. If you must clean it, please try to blow it off or pick out the dirt very lightly. Please do not try to wipe it, which may cause more scratches.



*Figure 1: Front View*

**Install the antenna:** The antenna is placed in the accessory slot on the right side of the package box. Please screw the antenna into the mounting base on the top of the camera and securely tighten it (*Figure 1*).

The camera provides the following connections for external devices: Mini USB port and SD card slot etc. (Figure 2).



The camera has one security cable hole and two strap holes on the back. The strap can be put through the strap holes and fastened securely around a tree trunk by pulling the end of the strap firmly (Figure 3).



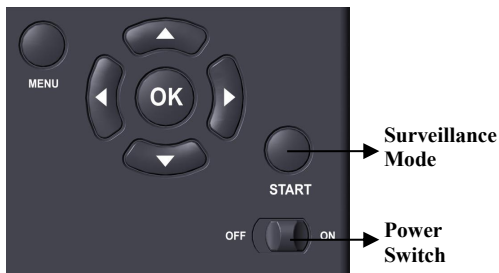
Figure 3: Right / Back View

The camera has a 2.4-inch built-in LCD screen, which can be used for reviewing pictures or videos and menu displaying, and

exclusive keypad design for easy program and operation, 8 AA batteries slot supported (*Figure 4*).



*Figure 4: Inside View*



*Figure 5: Operation Buttons*

A power switch is used to power on (**ON** mode) or off the camera (**OFF** mode). A **START** button is used to quickly make the camera into the surveillance mode (motion detection) or time lapse per your settings (*Figure 5*). When the camera is in the surveillance mode, press the **START** button to wake up the camera.

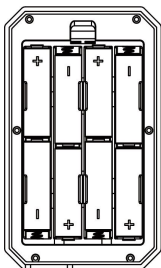
## 5. INSTALLING THE BATTERIES AND SD CARD

Before you begin learning how to use your camera, you will first need to install a set of batteries and insert an SD card. Although that may only take you a minute, there are some important notes about both batteries and SD cards you should be aware of, so please take the time to **read the following directions and cautions**:

### 5.1. Loading Batteries

After opening the cover of the battery compartment, you will see that the camera has eight battery slots (*Figure 6*). A full eight batteries must be installed for the camera to operate. Be sure to insert each battery with correct polarity (negative or "flat" end against the long spring of each battery slot).

In **ON** mode when battery power level gets low, the message "**Low Battery**" will show on the screen, please replace the batteries. If the battery indicator shows in **RED**, this does mean the batteries are not able to drive IR LEDs flash at night, however the batteries still work at daytime until "**Low Battery**". If you want to continue night vision, please replace the batteries.



*Figure 6: Loading the Batteries*

## 5.2. Inserting the SD Card

Insert the SD card (with the camera powered off), before beginning to operate the camera. Don't insert or remove the SD card when the camera is powered on or in the surveillance mode (*Figure 7*).



*Figure 7: Inserting the SD Card*

The following describes how to insert and remove the SD card:

- Insert the SD card into the card slot with its label side upwards. A "click" sound indicates that the card is installed successfully. If the wrong side of the card is facing up, you will not be able to insert it without force, there is only one correct way to insert cards. If the SD card is not installed correctly, the device will not display an SD card icon on the screen in **ON** mode. **Formatting the SD card** by using the camera's "Format SD Card" menu option before first use is recommended, especially when a card has been used in other devices.
- To take out the SD card, just gently push in the card (do not try to pull it out without pushing in first). The card is released from the slot and ready to be removed when you hear the click. Be sure the camera's power is switched **OFF** before inserting or removing SD cards or batteries.

## 6. USING THE CAMERA

Once you've prepared your camera by properly installing

batteries and an SD card, you could simply take it outside, strap it to a tree (or not - according to your application scenario), switch it **ON**, press **START** button and leave-and you might get some great photos that are exactly what you wanted. However, we highly recommend that you first spend some additional time indoors with this manual and your camera until you know a bit more about what those control keys do. If nothing else, you'll probably want to at least set the date and time so the camera will imprint them (or not-it's your option) on your photos as they are taken, learn how to set the camera to shoot video clips instead of still photos if you like, and read some tips about mounting it on a tree.

## **7. THE OFF, ON, AND SURVEILLANCE MODES**

The camera has three basic operational modes:

- **OFF** mode: Power switch in the **OFF** position (The camera is powered off).
- **ON** mode: Power switch in the **ON** position (The camera is powered on and its screen is on).
- **SURVEILLANCE** mode: When the camera is powered on, press **START** button to enter the surveillance mode. When the screen is off, the camera enters standby and will perform according to your settings.

### ***App & Wi-Fi Connection:***

You can use the App to connect the camera when the camera is operating in the ON or SURVEILLANCE mode.

#### ***7.1. OFF Mode***

The **OFF** mode is the "safe" mode when any actions must be taken, e.g., replacing the SD card or batteries, or transporting the device. And of course, when you are storing or not using

the camera, you will switch it to **OFF**. Please note that in the **OFF** mode the camera still consumes a little power. It's a good idea to take the batteries out of the battery compartment if the camera will not be used for a long time.

## **7.2. ON Mode**

In the **ON** mode you can check and change the settings of the camera with the help of its built-in screen. These settings, found in the menu by pressing **MENU** key, let you change the photo or video resolution, interval between photos, switch the time imprint on, etc. (See more in **Section 9 ADVANCED SETTINGS**).

On the screen display, you will see an information screen that shows how many images have been taken, the battery level, camera or video mode, etc.

***Attention please:** In the **ON** mode, the camera will automatically enter **SURVEILLANCE** mode if there is no operation (key pressing) within 5 minutes. Then the camera will perform as your settings in the menu.*

In the **ON** mode, you can connect the camera to a computer's USB port to download your images.

## **7.3. SURVEILLANCE Mode**

Any time after the batteries and SD card have been inserted, you can switch on the camera. When the **START** button is pressed, the camera will enter into the **SURVEILLANCE** mode. If the Mode in the settings is set as “Motion Detection”, the camera will count down a 30-second delay and then be ready to capture images. If the Mode is set as “Time Lapse”,

there will be no 30-second counting down, and the camera will be ready to enter Time Lapse.

Once in the **SURVEILLANCE** mode, no manual controls are needed or possible (the control keys have no effect). The camera will take photos or videos automatically (according to its current parameter settings).

**TIP:** You can press the **START** button again to wake up the camera and reprogram your camera if required.

## 8. Wi-Fi CONNECTION

### 8.1. Download Meidase Mobile App

Before using the Wi-Fi functionality, please download the ‘Meidase Mobile’ App.



#### **NOTES:**

The screenshots shown in this section are indicative only. The actual diagram on different versions of App, iOS and Android may differ.

During the use of the Meidase App (Referred to as App), please grant the App access to Wi-Fi, Bluetooth, storage, location and camera of your device, and enable the Local Network (if on iOS14), which are necessary to take pictures and videos.

## 8.2. Enable Wi-Fi and Bluetooth

Enable Wi-Fi and Bluetooth on your mobile phone before opening the App. This step is optional, however it can speed up the connection between App and camera.

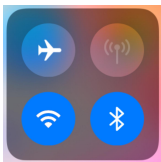


Figure 8: Enable Wi-Fi and Bluetooth

## 8.3. Add Your Camera

Ensure that your camera is in ON mode and in close proximity to you. To establish a stable connection, move within 45ft of the camera with no obstacles obstructing the signal, such as walls or glass doors.

Open the App, tap **Wi-Fi camera** (Figure 9).

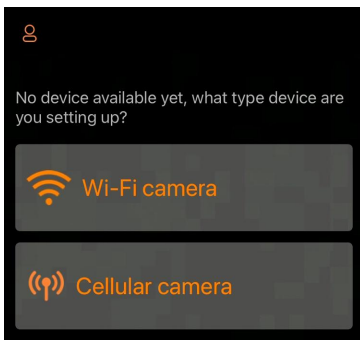
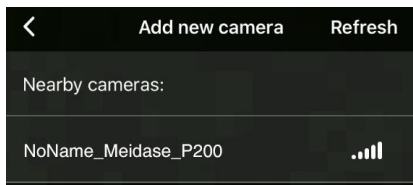


Figure 9: Tap to add your camera

**NOTE:** The App is an unified App, supports Wi-Fi camera and cellular camera (sold separately).

#### 8.4. Search Your Camera and Link



*Figure 10: Select your camera*

By default, in the list the camera will be indicated as ID “**NONAME\_Meidase\_P200**” if the camera name is not assigned. After you set the camera name in settings, the camera ID will be updated as “XXXX\_Meidase\_P200” (XXXX is a 4-character choice, you can set your camera name).

The App automatically searches for all Wi-Fi trail cameras nearby, please make sure your camera is within the Wi-Fi range. This process may take up to 15 seconds. If there is no device shown in the list, please click the Refresh button on the top-right corner.

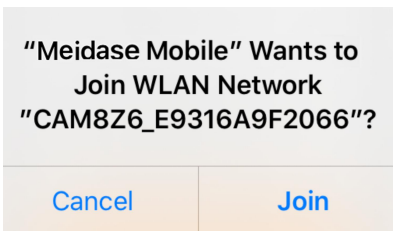
Tap the one you want to add (*Figure 10*). The App starts connecting to your camera. It might take up to 15 seconds to build the Bluetooth and Wi-Fi connection between the App and camera. There are 4 steps (Illustration omitted):

*Step1 – Connecting through Bluetooth...*

*Step2 – Activating the camera...*

*Step3 – Searching Wi-Fi... The camera display will turn off during Wi-Fi connecting.*

*Step4 – Connecting through Wi-Fi...*



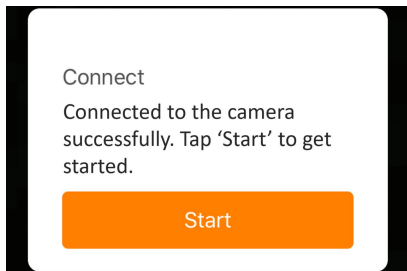
*Figure 11: Allow Wi-Fi Connection on iOS Device*

A system pop-up message will show (*Figure 11*).

Please tap 'Join' to allow Wi-Fi connection. The string "CAM8Z6\_E9316A9F2066" is the name of Wi-Fi hotspot on the camera to allow Wi-Fi connection. Among cameras, the prefix CAM8Z6 is fixed, E9316A9F2066 is the internal camera identifier which may vary from different cameras.

**NOTE:** *On Android devices, there might be different system pop-up messages that ask for allowing App connection to camera since different mobile phone manufacturers may modify and customize this system message.*

After connected, a pop-up message would show as below:



*Figure 12: Connected*

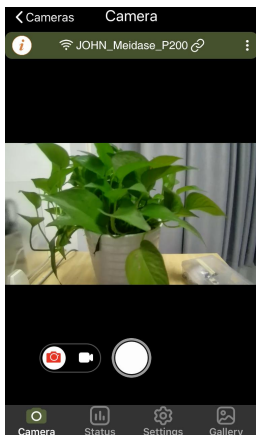
Tap "Start" to enjoy your App journey (*Figure 12*).

## 8.5. App Navigation

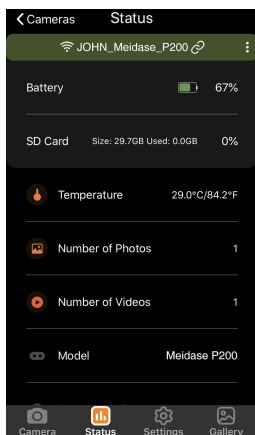
The App supplies 4 main features: Camera, Status, Settings and Gallery. See the *Table 1* and *Figure 13~16* for more details.

*Table 1 - App Navigation*

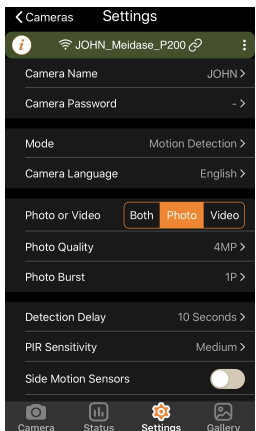
<b>Features</b>	<b>Details</b>	<b>Refer to</b>
<b>Camera</b>	Preview, manual taking pictures or videos. <i>Note: When your Wi-Fi camera is connected, motion detection will be disabled. It will be enabled again when you disconnect your Wi-Fi camera or close the App for 90 seconds.</i>	<i>Figure 13</i>
<b>Status</b>	Camera status, including battery level, SD Card capacity and used size, internal temperature of the camera, number of pictures and videos stored on the SD Card, camera model, firmware version number, etc.	<i>Figure 14</i>
<b>Settings</b>	Display or program camera settings, such as mode, picture quality etc.	<i>Figure 15</i>
<b>Gallery</b>	Review or download the pictures or videos the camera has taken.	<i>Figure 16</i>



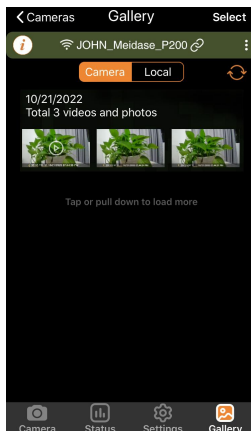
*Figure 13: Camera*



*Figure 14: Status*

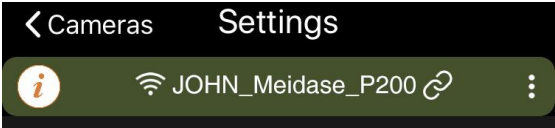


*Figure 15: Settings*



*Figure 16: Gallery*

## 8.6. Important Notes on App Wi-Fi Connection

No.	Notes
1	<p>When the camera's Wi-Fi is connected, the camera will stop SURVEILLANCE (motion detecting or time lapse). Disconnect Wi-Fi to enable the camera to go back to SURVEILLANCE mode.</p> <p><b>TIP: How to re-enable the camera start motion detection?</b></p> <p>Tap the camera ID "JOHN_Meidase_P200" to disconnect or remove the current camera, or add new camera (refer to the following figures).</p> 
2	<p>On the phone device, when the App is closed or runs in the background, there is a maximum of 90-second timeout of Wi-Fi connection between App and camera, before timeout, you can re-open and operate on the App without reconnecting. However, the camera will not work (capture motions) until the Wi-Fi timeout is done. Before timeout, you must disconnect Wi-Fi manually to enable the camera to capture motions.</p>
3	<p>When the App connects to the camera, the RED indicator will flash once.</p>

## 9. ADVANCED SETTINGS

The trail camera comes with preset manufacturer settings. You can change the settings to meet your requirements. Once the camera screen is on, press **MENU** key to enter/exit the menu. Press the **UP/DOWN** key to move the marker, Press the **LEFT/RIGHT** key to change the setting, and press the **OK** key to confirm the change. Always remember to press the **OK** to save the change. Otherwise, you will lose your new setting.

*Table 2 – Camera Settings*

<b>Parameter</b>	<b>Settings</b> ( <b>Bold</b> = default)	<b>Description</b>
<b>Mode</b>	Motion Detection, Time Lapse, Hybrid	In <b>Motion Detection</b> mode, the camera will take photos or videos once triggered. In <b>Time Lapse</b> mode, the camera will take photos or videos periodically according to your preset “Timelapse Interval” parameter. <b>Hybrid</b> mode includes both above.
<b>Photo or Video</b>	<b>Photo</b> , Video, Photo+ Video	Select whether still photos or video clips are taken.
<b>Photo Quality</b>	48MP 32MP 24MP 16MP 8MP 4MP	Select desired resolution for still photos. Higher resolution produces better quality photos, but creates larger files that take more of the SD card capacity. Larger files require longer time to write to the SD card, which will slightly slow the shutter speed.

<b>Photo Burst</b>	<b>01, 02, 03, 04, 05</b>	Select the number of photos taken in sequence per trigger.
<b>Video Quality</b>	1296P <b>1080P</b> 720P	Select video resolution (pixels per frame). Higher resolution produces better quality videos, but creates larger files that take more of the SD card capacity.
<b>Video Length</b>	<b>10 seconds,</b> Optional from 3s to 5m	Select video recording length. <i>Note: It is highly recommended to set the night video length to less than 30 seconds as the IR LEDs will consume more battery power.</i>
<b>Video Sound</b>	<b>On</b> Off	Selecting <b>On</b> will record video with sound.
<b>Video Format</b>	<b>MP4</b> MOV	MP4 is the mainstream format in the video industry, more compatible with any player. Select MOV in case some legacy digital camera software must be working with videos in MOV format.
<b>Detection Delay</b>	<b>10 seconds,</b> optional from 0s to 60m	Select the shortest length of time that the camera will wait until it responds to any subsequent triggers from the PIR sensor after a game is first detected. During the selected interval, the camera will not take pictures/videos. This prevents the SD card from filling up with too many redundant images. 0 means capture as fast as possible. <i>Note: this option is invalid if <b>Mode</b> is set as "Time Lapse".</i>
<b>PIR Sensitivity</b>	<b>High,</b> Medium	Select the sensitivity of the PIR sensor. Temperature affects the sensitivity. The

	Low	High setting is suitable when the ambient temperature is warm or you want to capture distant objects or capture more, and the Medium/Low setting is helpful in cold weather. <i>Note: this option is invalid if <b>Mode</b> is set as “Time Lapse”.</i>
<b>Side Motion Sensors</b>	On Off	Selecting <b>On</b> will activate the side motion sensors. It brings faster trigger speeds and helps capture fast moving animals. When any of the two side motion sensors detects a motion event, the camera will be pre-activated. While the animal enters the detection area of the center motion sensor, the camera will start taking photos or videos. Select <b>Off</b> to save batteries power.
<b>Motion Test</b>		This feature helps you aim the camera at your target area. Please refer to the details in <i>Section 10.2</i> .
<b>Timelapse Interval</b>	<b>First Shot Time:</b> hh:mm	Set the earliest shot time after Time Lapse or Hybrid mode is enabled. If you would like to get photos earlier, it is recommended to set it later than the current time.
	<b>Interval:</b> optional from 3s to 24h	Set time lapse interval. It takes effect <b>ONLY</b> when <b>Mode</b> is set as Time Lapse or Hybrid, the camera will automatically take photos/videos according to the set interval, regardless of whether the PIR sensor has detected any game. This is helpful when observing cold-blooded

		<p>animals like snakes, or the process of flowering, etc.</p> <p><i>Note: This option is invalid if <b>Mode</b> is set as "Motion Detection".</i></p>
<b>Timelapse Period</b>	<b>On Off</b>	<p>Selecting <b>On</b> to set a specific working time period for your camera in Time Lapse mode or Hybrid mode. You can set up to 2 different time periods for the camera, and it will not capture time-lapse photos or videos outside of those periods.</p> <p><i>Note: This option is invalid if <b>Mode</b> is set as "Motion Detection".</i></p>
<b>WIFI</b>	<b>On/Off</b>	<p>Selecting <b>On</b> to enable Wi-Fi, you can use the App to connect the camera. Selecting <b>Off</b> to disable Wi-Fi, the camera will operate in stand-alone mode and save battery power.</p> <p><i>Only change CHX when you feel WiFi signal is not good or you have multiple WiFi cameras nearby.</i></p>
<b>Date / Time</b>	M/D/Y hh:mm AM/PM	<p>M – Month, D – Day, Y – Year hh – Hour, mm – Minute</p> <p><i>Note: Use "<b>LEFT/RIGHT</b>" key to switch parameters, use "<b>UP/DOWN</b>" to set current date and time. Date input format may change. Please refer to "<b>Date Format</b>" parameter settings accordingly.</i></p>
<b>Date Format</b>	D/M/Y M/D/Y Y/M/D	Select date format which will be shown on the screen and each capture.

<b>Time Format</b>	<b>12h</b> <b>24h</b>	Select time format which will be shown on the screen and each capture. 12h - AM/PM
<b>Camera Name</b>	<b>On</b> <b>Off</b>	Select <b>On</b> to assign a name, 4-character long, in the form of Capital A-Z, 0-9 to record the location in the photos (e.g. A123 for Yellow Stone Park). This helps multi-camera users identify the location when reviewing the photos.
<b>Info Strip</b>	<b>On</b> <b>Off</b>	Select <b>On</b> to show date, time, temperature, moon phase on each capture.
<b>Loop Recording</b>	<b>On</b> <b>Off</b>	Selecting <b>On</b> option will cause the oldest files to be overwritten with new captures when the SD card reaches its capacity. With <b>Off</b> option selected, the camera will stop capturing images once the SD card reaches capacity.
<b>Operation Hours</b>	<b>On</b> <b>Off</b>	Select <b>On</b> if you only want the camera to work within a specified time period every day. For instance, if the starting time is set at 18:35 and the ending time at 8:25, the camera will function from 18:35 the current day to 8:25 the next day. Outside the time period the camera will not be triggered. <i>Note: This option is ONLY valid if <b>Mode</b> is set as "Motion Detection" .</i>
<b>Password</b>	<b>On</b> <b>Off</b>	Set up a 4-digit password to protect your camera from unauthorized users. If the code is lost, you can contact customer support to reset the password.

<b>Format SD Card</b>	Yes No	All files will be deleted after formatting the SD card. It's highly recommended that you format the SD card if it has been used previously in other devices. <b><i>Caution: make sure wanted files on the SD card have been backed up first!</i></b>
<b>Factory Reset</b>	Yes No	Selecting <b>Yes</b> will return all your previous settings back to the manufacturer default.
<b>Version</b>	Defined	Display the version of the camera.

## 10. MOUNTING AND POSITIONING

### 10.1. Mounting

After you've set up the camera's parameters to your personal preferences at home, you're ready to take it outside. When setting up the camera for scouting game or other outdoor applications, you must be sure to mount it in place correctly and securely. We recommend mounting the camera on a sturdy tree with a diameter of about 6in. (15cm). To get the optimal picture quality, the tree should be about 16-17ft. (5m) away from the place to be monitored, with the camera placed at a height of 2.5-3.5ft. (0.75-1m). Also, keep in mind that you will get the best results at night when the subject is within the ideal flash range, no farther than 100ft. (30m) and no closer than 10ft. (3m) from the camera.

There are two ways to mount the camera: using the provided adjustable web belt, or the tripod socket.

**Using the adjustable strap:** In order to use the strap on the camera, push one end of the strap through the two brackets on the back of the camera. Thread the end of the strap through the

buckle. Fasten the strap securely around the tree trunk by pulling the end of the strap firmly so there is no slack left (*Figure 17*).

**Using the tripod socket:** The camera is equipped with a socket at the bottom end to enable mounting on a tripod or other mounting accessories with a standard *UNC 1/4-20* thread screw (*not included*).



*Figure 17: Mounting the Camera*

## ***10.2. Sensing Angle and Distance Test***

To test whether the camera can effectively monitor the area you choose, this test is recommended to check the sensing angle and monitoring distance of the camera. To perform the test:

- Switch the camera to the **ON** mode.
- Press **MENU** button, go to “Motion Test”. The camera will count down a max 60-second delay and be ready to capture motion. (*Note: The delay time may be less than 60 seconds, depending on the actual time of the motion sensor to be activated. The delay time is 60 seconds minus the power-on time.*)
- Close the camera door.
- Make movements in front of the camera at several positions

within the area where you expect the game or subjects to be. Try different distances and angles from the camera.

- If the motion indicator RED light blinks, it indicates that position can be sensed. If it does not blink, that position is outside of the sensing area.
- In these sensing tests, the camera will take pictures once motion is captured. When you open the camera, the screen shows the number of times triggered, you can review the pictures on the screen. *(Note: The red light will blink only when the motion is within the sensing area of the central PIR sensor. The central sensor's sensing angle of view is 60°. Each of the side sensors has a 30° angle of view, which is only used to pre-activate the camera and accelerate the triggering speed, there is no RED light blinking whatever each of the side sensors detects motions.)*

The results of your testing will help you find the best placement when mounting and aiming the camera. The height above from the ground for placement of the device should vary with the size of animal you are hoping to see. In general, 3 to 6 feet is preferred.

You can avoid potential false triggers due to temperature and motion disturbances in front of the camera by not aiming it at a heat source or nearby tree branches or bush (especially on windy days).

Do NOT install the camera behind the glass window as that is not possible to sense any motion. Avoid aiming the camera toward to any glass objects.

### ***10.3. Starting***

The camera supports three working modes, "Motion Detection", "Time Lapse" and "Hybrid", press **START** button to enter

surveillance mode.

(1) If you set the camera's working mode as "Motion detection" in the menu, the camera will count down a 30-second delay, and then will be ready to go into standby (surveillance) and capture. Any motion that is detected by it will trigger the capture of an image or video as programmed in the menu. Be sure you have read the descriptions of the Detection Delay, and PIR Sensitivity parameters.

(2) If you set the camera's working mode as "Time Lapse" in the menu, the camera will be ready to go into "Time Lapse" mode soon after the START button is pressed, and then will take images periodically according to your preset "Timelapse Interval" parameter, regardless of the settings "Detection Delay".

(3) If you set the camera's working mode as "Hybrid" in the menu, the camera will work according to the above two modes.

## **11. REVIEW PHOTOS OR VIDEOS**

After you have setup, mounted and activated your CAMERA, you will of course be eager to return later and review the images it has captured for you. The camera stores photos and videos in the folder \DCIM\100MEDIA in the SD card. Photos are saved with file names like DSCF0001.JPG and videos like DSCF0001.MP4. The MP4 video files can be played back on most popular media players, such as Windows Media Player, QuickTime, VLC etc.

There are different ways this can be done.

You can review photos or videos directly on the camera screen or in the app's gallery bar.

Or when the camera is powered on, you can use the provided USB cable to download the files to a computer.

Or you can put the SD card into an SD card "reader" (*not included*), plug into a computer, and browse the files on the computer without downloading.

## 12. TECHNICAL SPECIFICATIONS

<b>Element</b>	<b>Description</b>
<b>Wi-Fi</b>	2.4GHz 802.11 b/g/n
<b>Bluetooth</b>	BLE 5.0
<b>App System Requirements</b>	IOS 11.0 or later Android 7.0 or later
<b>Working Mode</b>	Motion detection, Time Lapse or Hybrid
<b>Max. Pixel Size</b>	48MP
<b>Optics Lens</b>	f/1.6, FOV=70°, Auto IR-Cut
<b>IR Flash</b>	100ft
<b>LCD Screen</b>	2.4" Color screen
<b>Keypad</b>	7 Keys, 1 Power switch
<b>Memory</b>	SD, SDHC or SDXC standard memory card (Not included), maximum capacity 512GB
<b>Picture Resolution</b>	48MP, 32MP, 24MP, 16MP, 8MP, 4MP
<b>Video Resolution</b>	2304 x 1296P@20fps (16:9), 1920 x 1080P@30fps (16:9), 1280 x 720P@30fps (16:9)
<b>PIR Sensitivity</b>	High/Normal/Low
<b>PIR Sensing Distance</b>	90ft (Below 77°F/25°C)
<b>PIR Sensing Angle</b>	Total 120° (while side motion sensors enabled). Central zone: 60°, Left side: 30°, Right side: 30°

<b>Trigger Time</b>	Approx. 0.1~0.5 seconds (0.1s while side motion sensors enabled)
<b>Trigger Interval</b>	0sec.-60min, Programmable
<b>Shooting Numbers</b>	1~5
<b>Video Length</b>	3sec ~ 5min., Programmable
<b>Info Strip</b>	On /Off
<b>Operation Hours</b>	On /Off, Specific working period of time
<b>Password</b>	4-Digit Code
<b>Camera Name</b>	4-Character (A-Z, 0-9)
<b>Time Lapse Interval</b>	2 Seconds ~ 24 Hours
<b>Power Supply</b>	8x1.5V AA Batteries (not included)
<b>Stand-by Time</b>	8 Months
<b>Auto Stand-by</b>	Auto Stand-by (Surveillance mode) in 5 minutes while no operation in <b>ON</b> mode
<b>Low Battery</b>	8V - Low Battery (Batteries die) 9V - Night vision is unavailable in low voltage (Almost die)
<b>Interface</b>	Mini-USB, Standard size SD card holder, External Power (DC 12V/1A, Plug 5.5x2.1mm)
<b>Mounting</b>	Strap, Tripod Base (1/4-20)
<b>Waterproof</b>	IP66
<b>Operation Temperature</b>	-4 ~ 140°F / -20 ~ 60°C
<b>Operation Humidity</b>	5% ~ 95%
<b>Product Dimensions</b>	5.6 x 4.2 x 2.86 inch

### 13. TROUBLESHOOTING

If your camera does not seem to be functioning properly or if you are having photo/video quality issues, please run these simple and quick checks:

- Make sure the camera is powered on and in the correct mode
- Format the SD card in the camera or replace the SD card, since the SD card is a storage media and sometimes it might be unstable
- Replace batteries if night vision seems not to be working as expected
- The dark background of night images is usually caused by strong reflections from the obstacles close to the camera. To get the best night image, please remove close-up obstacles (such as walls or tree trunks) in front of the camera as possible, or adjust the installation position of your camera to avoid these obstacles (*Figure 18*)



*Figure 18: Avoid close-up obstacles in front of the camera*

If your unit is still having trouble, please contact us, providing us with your order number, or **check the website to determine that you are using the latest firmware and App.** Please be assured we will make the things right for you.

## **14. WARRANTY**

### **ONE YEAR LIMITED WARRANTY**

**Your Meidase Trail Camera warranty covers your trail camera for one year after the original purchase date.** We warrant that your camera will be free from defects in materials and workmanship when operated in normal use and conditions. This warranty does not cover consumer caused damages such as misuse, abuse, improper handling or installation, damaged caused by wild animals, or repairs attempted by someone other than our authorized technicians.

We will, at our option during the warranty period, repair your camera or replace it with the same or comparable model free of charge. This warranty only extends to the original retail buyer from our authorized dealer. Purchase receipt, order number or other proof of the date of the original purchase is required to receive warranty benefits. The warranty on any replacement product provided under the original warranty shall be for the remaining portion of the warranty period applicable to the original product.

This warranty extends solely to failures due to defects in materials or workmanship under normal use. It does not cover normal wear of the product.

If you need to return a product under this warranty, please contact your dealer or our distributor.